



**MFSC 5000W-6000W CW Fiber Laser Series**

# USER GUIDE

# Copyright Notation

Copyright © Maxphotonics Co., Ltd ( here after referred to as Maxphotonics). All rights reserved. You may not copy, modify, transmit or publish this publication, in any form, in any media or by any means, without the prior written permission of Maxphotonics, except as allowed under applicable copyright laws. Permitted copies shall bear the same copyright and proprietary notices that were contained on the original version.

Maxphotonics believes that the information provided is accurate and reliable; however Maxphotonics makes no warranty, representation, expression or implication that this document can be used as reference in other occasions. Furthermore, Maxphotonics does not assume responsibility for any infringement of patents or other rights of third parties due to use of the information contained in this document. Maxphotonics shall not be liable for errors contained in this document or for direct or indirect damages of relevant equipment.

Maxphotonics and the Maxphotonics Logo are registered trademarks of Maxphotonics Co., Ltd., and the Logo does not break any regulations of Trademark law. Maxphotonics grants no rights for patent or other intellectual property mentioned herein.

All information contained in this document is subject to change and revision without notice.



## **Maxphotonics Co.,Ltd.**

Address: Maxphotonics Industrial Park, 3rd Furong Road,  
Furong Industrial Area, Shajing, Baoan, Shenzhen, China.518125

E-Mail: [info@maxphotonics.com](mailto:info@maxphotonics.com)

<http://en.maxphotonics.com>

Subject to change without notice. © Maxphotonics Co., Ltd.

## Preface

Thank you for using the MFSC 5000W-6000W CW Fiber Laser Series from Maxphotonics. We compile this document for you in order that the laser is used and maintained properly. Due to the limited level of the writers, coupled with time constraints, there are some careless mistakes in this document, your understanding and suggestion to help us make an improvement will be much appreciated . Thank you again for using Maxphotonics' products.

Please take time to read and understand this User's Guide and familiarize yourself with the operating and maintenance instructions before you use the product. We strongly recommend that the operator read the Section 2 titled "Safety Information" prior to operating the product.

This User's Guide should stay with the product to provide you and all future users and owners of the product with important operating, safety and other information.

We identify the parts to which you need to pay special attention in the document with underscore. Please notice those information to prevent the unnecessary damages.

## Company Profile

Found in 2004, Maxphotonics is one of the first fiber laser manufacturers in China. It is also the first in China to realize independent intellectual property rights and vertical integration in the core technologies of fiber lasers and optical devices. One of the national high-tech enterprises. Maxphotonics has developed into an internationally renowned laser manufacturer that develops, manufactures and sells fiber lasers and core optical components. It is the second largest domestic fiber laser manufacturer in the domestic market.

Maxphotonics specializes in the research, development, production and sales of fiber lasers, including pulsed fiber lasers, continuous fiber lasers and direct diode lasers. It also implements pump sources, combiners, fiber gratings, isolators, laser output heads, and stripping. Optical devices such as molds, acousto-optic modulators, and pattern matchers are produced autonomously. Products are widely used in marking, engraving, cutting, drilling, cladding, welding, surface treatment, rapid prototyping and additive manufacturing processes.

More informations, please visit our website:

<http://en.maxphotonics.com>

<b>Company Profile</b> .....	<b>2</b>
<b>Chapter 1 Characteristic Description</b> .....	<b>5</b>
<b>Chapter 2 General Safety Information</b> .....	<b>6</b>
1-Safety Conventions .....	6
2-Laser Protection .....	7
3-Reference Standard .....	8
4-General Safety Instructions .....	9
5-Additional Safety Information .....	14
<b>Chapter 3 Product Description</b> .....	<b>15</b>
1-Features.....	15
2-Module Configuration .....	15
3-Laser Model Designation Codes .....	15
4-Certification .....	16
5-Front Panel Description .....	16
6-Back Panel Description .....	17
7-Optical Output Terminal .....	17
<b>Chapter 4 Specification</b> .....	<b>18</b>
1-Optical Characteristic Parameters .....	18
2-General Characteristic Parameters .....	19
3-Water Cooling Condition.....	19
4-QBH Water Cooling Condition .....	20
5-Installation Environment Requirements .....	21

6-Structural Layout .....	23
<b>Chapter 5 Unpacking Guide .....</b>	<b>24</b>
1-Unpacking Steps .....	24
2-Packing List .....	26
<b>Chapter 6 Operation Guide.....</b>	<b>27</b>
1-Notice .....	27
2-Electrical Power Connection .....	27
3-Extension Interface .....	27
4-Start Steps.....	29
5-Mode Description .....	30
6-Software Description .....	31
7-Error List .....	35
<b>Chapter 7 Fiber Connector Inspection and Cleaning Guide .....</b>	<b>36</b>
1-Notice .....	36
2-Operating Procedures.....	37
<b>Chapter 8 Service and Maintenance .....</b>	<b>41</b>
1-Maintenance Notes .....	41
2-Service Statements .....	42
<b>Chapter 9 Warranty Statements .....</b>	<b>43</b>
1-General Items .....	43
2-Warranty Limitations .....	43

# Chapter 1

## Characteristic Explain

MFSC Series CW Fiber Laser products provide a wide range of wavelength from 1060nm to 1100nm. The lasers are water-cooled and maintenance-free and with a wall plug efficiency of more than 30% and deliver high efficiency, high reliability and high performance.

Maxphotonics' MFSC Series CW Fiber Laser Series are Class 4 laser products and are designed and tested with safety. By following this User Guide and applying sound laser safety practices, it will be a safe and reliable device.

Laser light exhibits unique characteristics that may pose safety hazards. Therefore, the laser light can't be normally associated with other light sources, and all operators and people near the laser must be aware of these special hazards.

In order to ensure the safe operation and optimal performance of the product, please follow all warnings and safety instructions in this guide during process of operation, maintenance and service.



For ensuring the safety of operators, operators are urged not to open the equipment privately at all times. There are no user serviceable parts, equipment or assemblies associated with this product. Lasers of unauthorized disassembly shall not be subject to warranty.

## Chapter 2

# General Safety Information

### 1-Safety Conventions

All safety warning symbols during operating process of the laser include:

SYMBOLS	DESCRIPTION
	<p><b>WARNING:</b> Refers to a potential Electrical Hazard to human body. It requires a procedure that, if not correctly followed, may result in bodily harm to you and/or others. Do not proceed beyond the <b>WARNING</b> sign until you completely understand and meet the required conditions.</p>
	<p><b>CAUTION:</b> Refers to a potential hazard on product. It requires a procedure that, if not correctly followed, may result in damage to the product or components. In order to ensure normal use of equipment, do not violate the requirement of the <b>CAUTION</b> sign.</p>
	<p><b>WARNING:</b> Refers to a potential Laser Hazard. The symbol represents laser radiation. The symbol is pasted on laser output end.</p>
<p>NO SYMBOL</p>	<p><b>IMPORTANT:</b> Refers to any information regarding the operation of the product. Please do not overlook this information.</p>



NOTE :

© This device is classified as a high power Class IV laser instrument. It may emit up to 6000W average power from 1060nm to 1100nm. This level of light may cause damage to the eye and skin. Despite the radiation being invisible, the beam may cause irreversible damage to the retina. Laser safety eyewear is not provided with this instrument, but must be worn at all times while the laser is operational.

## **2-Laser Protection**

### **1、 Laser Protection Requirements**

You must wear the safety protective glasses while operating the laser, and rationally select the safety protective glasses according to the lasing wavelength of the laser. If the device is a tunable laser or Raman product, it emits light over a range of wavelengths and the end user should confirm the laser safety eyewear used protects against light emitted by the device over its entire range of wavelength.

### **2、 Laser Protective Equipment Suppliers**

Maxphotonics recommends material or equipments provided by following laser protective equipment suppliers for you, including LaserVision USA, Kentek Corporation, Rochwell Laser Industries, etc. All the supplier information is provided by Maxphotonics only for the convenience to use, so Maxphotonics assumes no responsibility for any problem caused by using the products of abovementioned suppliers.

### 3-Reference Standard

**Electromagnetic compatibility and anti-interference:**

EN 61000-6-4: 2007 + A1: 2011

CISPR 16-2-1

CISPR 16-2-3

FCC PART 15 Class A

ICES-003 issue 6, Class A

EN 61000-6-2: 2005

EN 61000-4-2: 2009

EN 61000-4-3: 2006 + A1: 2008 + A2: 2010

EN 61000-4-4: 2012

EN 61000-4-5: 2014

EN 61000-4-6: 2014

EN 61000-4-11: 2004

**Laser safety:**

EN 60825-1: 2014

CDRH 21 CFR 1040.10

**Functional safety:**

EN 60204-1: 2018

**NOTE:**

© In accordance with relevant EU and national standards and requirements, the laser must be classified according to its output power and laser wavelength. All MFSC-3000W-4000W-Series laser products with high power belong to Class 4 products (according to article 8, EN 60825-1).

## 4-General Safety Instructions

### 1、Specular Reflection

There are often numerous secondary laser beams produced at various angles in the output port of the laser. These divergent beams are produced when the primary beam of laser reflects off a smooth surface, and they are called specular reflections. Although these secondary beams may be less powerful than the total power emitted from the primary beam, the intensity may be great enough to cause damage to the eyes and skin as well as surface of materials.

WARNING:

☉ You must exercise caution to avoid/minimize specular reflections as these laser radiations are invisible!

### 2、Safety Instructions of Accessories

The photosensitive elements integrated in laser-related optical accessories may be damaged by laser exposure, such as video cameras, photomultiplier tubes, and photodiodes. Attention should be paid to related device protection.

WARNING :

☉ The Maxphotronics MFSC laser light is strong enough to cut or weld metal, burn skin, clothing and paint. In addition, this light can ignite volatile substances such as alcohol, gasoline, ether and other solvents. During the operating process, the flammable materials around the laser must be isolated.

### 3、Optical Operating Instructions

We strongly recommend that you read the following procedures before operating the laser:

- 1、 Never look directly into the laser output port when the power is turned on.
- 2、 Avoid positioning the laser and all optical output components at eye level.
- 3、 Equip with laser beam casing.
- 4、 4. Make sure to remove the tail cover of the laser output head before the laser is turned on, otherwise it will cause irreversible damage to the laser fiber output head.
- 5、 Ensure that all personal protective equipment is suitable for the output power and wavelength range of the laser.
- 6、 Use the laser in a room with access controlled by door interlocks. Post warning signs. Limit the safety areas to operate the laser.
- 7、 Please do not operate the laser in darkened environments.
- 8、 Do not turn on the laser without an optical coupling fiber or an optical output connector.
- 9、 Carry out commissioning, calibration and focusing at low output power and then increase the output power gradually when the calibrating and focusing work is done.
- 10、 Do not install or detach cutting heads or collimators when the laser is active
- 11、 Make sure that the laser is shut down and the power is off before you install or detach cutting heads or collimators.
- 12、 If the equipment is operated in a manner not specified in this document, the protection devices and performance of the equipment may be impaired and the warranty will be voided.

**CAUTION:**

© The output of the laser is delivered through a lens with an anti-reflection coating. If the backward-stage light path of your laser has the optical lens, please strictly inspect the lens of the output head and the backward-stage lens

of the laser, and ensure that there is no dust and any other impurity on the lens. Please note that any macroscopic attachment may cause extreme damage to lens or burn the laser or any backward-stage light path equipment.

- ◎ For cleaning instructions of the lens, please refer to the "Optical Fiber Connector Inspection and Cleaning Guide".
- ◎ Hot or molten pieces of metal may be produced when the laser is under operation. Exercise caution if debris is produced in operation.
- ◎ When you carry out commissioning and calibration of the laser output, you must set the laser output at low power level and then gradually increase the output power during checking the quality of the light spot emitted from the laser via an infrared viewer.

**WARNING:**

- ◎ Make sure that the individual protective equipment meets the output power and wavelength range of the laser.
- ◎ Never look directly into the optical fiber or the collimator, and make sure you wear the safety protective glasses in each operation.

#### **4、Electrical Operating Instructions**

We strongly recommend that you read the following procedures before operating the laser:

- 1、Make sure the shell of this equipment is properly grounded. Any interruption of the ground loop may result in personal injury.
- 2、Make sure the power source connecting equipment is properly grounded.
- 3、In order to further reduce fire hazard, replace the line fuses (if applicable) with the same types and ratings. The use of other fuses or material is prohibited.
- 4、Make sure that the input AC voltage of the laser is the voltage of the normal AC mains (Three-phase four-wire 360-440VAC), and wires are connected accurately. Any incorrect wiring method may cause damage to people or

instrument.

5、 The equipment does not have any part which can be maintained by operators, and all the maintenance operations must be finished by the professionals of Maxphotonics Co., Ltd.

6、 To prevent electrical shock, do not remove enclosure, detach the laser without permission and damage the relevant signs. Any product with unauthorized dismounting shall not be subject to warranty.

**WARNING:**

☉ The input voltage of the laser is triple-phase AC current (360-440VAC), which may cause risk of electric shock. All the relevant cables and connection wires have potential hazards.

## **5、 Environment Conditions and Precautions**

For ensuring the safety of the laser working area, suitable enclosures shall be applied, including but not limited the laser safety signs and the interlocking devices. Corresponding operators must be trained and examined and know the normal safety specifications for operating the laser.

Meanwhile, it is important that the output components shall not be installed at eye level.

Because of interaction of the laser and the metal material, the radiation of high-level ultraviolet light or visible light may be produced. Make sure that the laser is provided with the protective cover to prevent the eyes or other parts of human bodies from damage by radiation.

**We recommend that you comply with the following operating measures to prolong the service life of the laser:**

- 1、 Do not expose the laser to a high moisture environment.
- 2、 Operation at higher temperature will accelerate aging, increase threshold current and lower slop efficiency. If the device is overheated, stop operations

and contact Maxphotonics.

3、 Ensure that the work surface is properly vented. There may be gases, sparks and debris generated from the interaction between the laser and the work surface, and they could pose additional safety hazard.

CAUTION :

© The device may be damaged with incautious operation.

## 5-Additional Safety Information

**For additional information regarding Laser Safety, please refer to the list below:**

Laser Institute of America(LIA)

13501 Ingenuity Drive, Suite 128

Orlando,Florida 32826

Phone:407 380 1553,Fax: 407 380 5588

Toll Free:1 800 34 LASER

American National Standards Institute

ANSI Z136.1, American National Standard for the Safe Use of Lasers

(Available through LIA)

International Electro-technical Commission

IEC 60825-1,Edition 1.2

Center for Devices and Radiological Health

21 CFR 1040.10 - Performance Standards for Light-Emitting Products

US Department of Labor - OSHA

Publication 8-1.7 - Guidelines for Laser Safety and Hazard Assessment.

Laser Safety Equipment

Laurin Publishing

Laser safety equipment and Buyer's Guides



# Chapter 3

## Product Description

### 1-Features

MFSC Series CW fiber lasers are compact and efficient and high-quality laser output lasers developed for industrial application. They are mainly applied to the fields of punching, welding, cutting, etc.

#### **Main Features:**

- 1、 High-quality laser output
- 2、 High power, high efficiency
- 3、 High reliability, long service life
- 4、 Compact, rugged package
- 5、 Extension programming interface

#### **Applications:**

- 1、 Industrial applications
- 2、 Scientific research

### 2-Module Configuration

Maxphotonics offers many configurable modes. This manual will give complete instructions for all modes, please refer to section 6.3-6.6.

### 3-Laser Model Designation Codes

M - F - S - C - XXX - XX 1 - 2 - 3 - 4 - 5 - 6		
1	Manufacturer's code	M means Maxphotonics
2	Gain media of the laser	F means Fiber Laser
3	Laser mode	S means Single Mode
4	Laser state	C means Continue Wave
5	Maximum output power	XXXX W means the maximum output power of the laser
6	Additional message	Can be null

#### 4 - Certification

Maxphotonics certifies that this equipment has been thoroughly tested and inspected and meets published specifications prior to shipping. Upon receiving your equipment, check whether the packaging and accessories have been damaged in transit. If damage is apparent, please contact Maxphotonics immediately.

#### 5- Front Panel Description



Items	Function Description
MAIN SWITCH	360-440VAC main power switch of laser
OFF ON	Power switch of laser
EMERGENCY	Emergency stop
START	Start laser (on-off signal of hardware)
ALARM	Abnormal situation light of laser
ACTIVE	Normal situation light of laser
POWER	Power light of laser

## 6-Back Panel Description



Items	Function Description
CTRL	External control connector
ETHERNET	Network communication interface
AC380V	360-440VAC power input
WATER OUT	Laser water cooling outlet (1 inch)
WATER IN	Laser water cooling water inlet (1 inch)

## 7-Optical Output Terminal

### 1、Optical Output Head

The optical output head come with a protective window that can be replaced if damaged. Make sure that the end cap of the QBH head is removed prior to use and is usually arranged with the laser.

Please refer to “Fiber Connector Inspection and Cleaning Guide” about the cleaning method.

Optical Output Head (QBH head)



Optical Output Head (G5 QBH head)



# Chapter 4

## Specification

### 1-Optical Characteristic Parameters

No.	Characteristics	Test Conditions	Min.	Nom.	Max.	Unit
1	Operation Mode	CW/Modulated				
2	Polarization	Random				
3	Output Power of MFSC-5000W	100% CW		5000		W
	Output Power of MFSC-6000W	100% CW		6000		W
4	Tuning Range of Output Power		10		100	%
5	Emission Wavelength	100% CW	1070	1080	1090	nm
6	Spectrum Width(3dB)	100% CW		4	7	nm
7	Short-term Power Instability	100% CW >1h		±1	±2	%
8	Long-term Power Instability	100% CW >24h		±3	±5	%
9	Beam Quality (BPP)	100% Output 100um QBH	3.0		3.8	mm x mrad
10	Laser Switching ON Time	10%→90% Output		150	200	μs
11	Laser Switching OFF Time	90%→10% Output		150	200	μs
12	Modulation Rate	100% Output			5	KHz
13	Red Guide Laser Power	100% Output	200			μW
14	Feeding Fiber Cable Length			20		m
15	Feeding Fiber Core Size	100 (150/200 optional)				μm
16	Feeding Fiber Cable Bending Radius		200			mm
17	Output Connector	Standard QBH (LOC)				

## 2-General Characteristic Parameters

No.	Characteristics	Test Conditions	Min.	Nom.	Max.	Unit
1	Operating Voltage		360	400	440	VAC
2	Input Power MFSC-5000W	100% Output			17	KW
	Input Power MFSC-6000W	100% Output			20	KW
3	Operating Ambient Temperature		10		40	°C
4	Operating Ambient Relative Humidity		10		85	%
5	Cooling Method	Water-cooling				
6	Storage Temperature		-10		60	°C
7	Dimensions	640*1000*700 (W*D*H)				mm
8	Weight	MFSC-5000W	225±5		kg	
		MFSC-6000W	230±5			

## 3-Water Cooling Condition

No.	Characteristics	Min.		Unit
1	Cooling Method	Water Cooling		
2	Water Temperature	Summer 24	Winter 20	°C
3	Hydraulic pressure	≥ 4		bar
4	MFSC-5000 water flow requirements	40		L/min
	MFSC-6000 water flow requirements	50		
5	MFSC-5000 Chiller rated cooling capacity requirements	12		kw
	MFSC-6000 Chiller rated cooling capacity requirements	14		

**CAUTION :**

- The Chiller needs to meet the requirements of the above table under the conditions of a circulating temperature of 40 ° C and an outlet temperature of 22 ° C.
- The above recommended water pressure requires the pressure drop of the main line  $\Delta p \leq 0.5\text{bar}$ . If this value is exceeded, the main circuit water pressure should be increased accordingly.
- The cooling water and filter element need to be replaced once a month; before winter (referring to low temperature environment of 0° C and below), the cooling water should be replaced with a suitable antifreeze (for example, glycol antifreeze, excessive addition is strictly prohibited, antifreeze thermal conductivity coefficient) Low, excessive addition may cause poor heat dissipation). After the winter is over, the antifreeze should be replaced with distilled water and the filter element should be replaced to restore the maintenance frequency once a month.

**4-QBH Water Cooling Condition**

Cooling Method	Water pipe size requirement	Water Flow Rate (L/min)	Hydraulic pressure (bar)	Cooling Temperature (°C)
Water cooling	Outer diameter* inner diameter= $\Phi 6*\Phi 4$	$\geq 2$	$\geq 3$	28-30

**NOTE:**

- External light path tube inner diameter  $\geq 8\text{mm}$ , length  $\leq 20\text{m}$ ;
- The length of the  $\Phi 6$  pipe connected to the LOE after switching from the external light path is  $\leq 1\text{m}$ ;
- QBH is connected in series with the cutting head;
- The above recommended external light path water pressure requires the pressure drop of the cutting head  $\Delta p \leq 1.5\text{bar}$ . If this value is exceeded, the external light path water pressure should be increased accordingly.

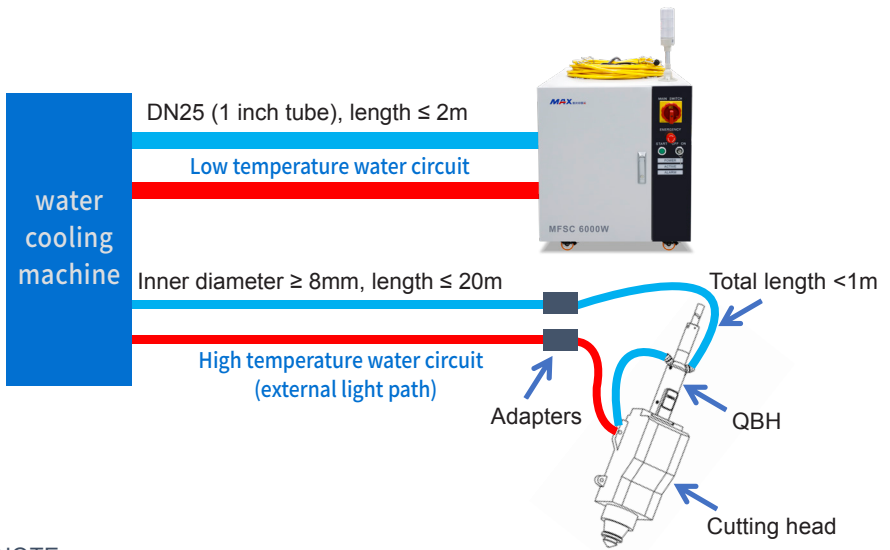

NOTE:

© Water pipe color: blue input water, red return water.

## 5-Installation Environment Requirements

- 1.The ambient air cleanliness grade requirement for optical fiber output head installation: 1000 or more stringent grade. Suggestions for Configuration of Standard Purification Workbench;
- 2.laser working environment temperature: $10^{\circ}\text{C}$ – $40^{\circ}\text{C}$ ;
- 3.laser working environment humidity: $10\%$ - $85\%$ ;
- 4.Avoid the condensation environment,the specific control standards are as follows:

相对湿度* 环境(°C)	环境温度、相对湿度、露点对照表													
	30	35	40	45	50	55	60	65	70	75	80	85	90	95
10	-7.0	-5.0	-3.0	-1.3	0.0	1.5	2.5	3.6	4.8	5.8	6.7	7.6	8.4	9.2
11	-6.5	-4.0	-2.0	-0.5	1.0	2.5	3.5	4.8	5.8	6.7	7.7	8.6	9.4	10.2
12	-5.0	-3.0	-1.0	0.5	2.0	3.3	4.4	5.5	6.7	7.7	8.7	9.5	10.9	11.2
13	-4.5	-2.0	-0.2	1.4	2.8	4.1	5.3	6.6	7.7	8.7	9.6	10.5	11.4	12.2
14	-3.2	-1.0	0.7	2.2	3.5	5.1	6.4	7.5	8.6	9.6	10.6	11.5	12.4	13.2
15	-2.3	-0.3	1.5	3.1	4.6	6.0	7.3	8.4	9.6	10.6	11.6	12.5	13.4	14.2
16	-1.3	0.5	2.4	4.0	5.6	7.0	8.3	9.5	10.6	11.6	12.6	13.4	14.3	15.2
17	-0.5	1.5	3.2	5.0	6.5	8.0	9.2	10.2	11.5	12.5	13.5	14.5	15.3	16.2
18	0.2	2.3	4.0	5.8	7.4	9.0	10.2	11.3	12.5	13.5	14.5	15.4	16.4	17.2
19	1.0	3.2	5.0	7.2	8.4	9.8	11.0	12.2	13.4	14.5	15.4	16.5	17.3	18.2
20	2.0	4.0	6.0	7.8	9.4	10.7	12.0	13.2	14.4	15.4	16.5	17.4	18.3	19.2
21	2.8	5.0	7.0	8.6	10.2	11.0	12.9	14.2	15.3	16.4	17.4	18.4	19.3	20.3
22	3.5	5.8	7.8	9.5	11.0	12.5	13.8	15.2	16.3	17.3	18.4	19.4	20.3	21.2
23	4.4	6.8	8.7	10.4	12.0	13.5	14.8	16.2	17.3	18.4	19.4	20.4	21.3	22.2
24	5.3	7.7	9.7	11.4	13.0	14.5	15.8	17.0	18.2	19.3	20.4	21.4	22.3	23.1
25	6.2	8.6	10.5	12.3	14.0	15.4	16.8	18.0	19.1	20.3	21.3	22.3	23.2	23.9
26	7.0	9.4	11.4	13.2	14.8	16.3	17.7	19.0	20.1	21.2	22.3	23.3	24.2	25.1
27	8.0	10.3	12.2	14.0	15.8	17.3	18.7	19.9	21.1	22.2	23.2	24.3	25.2	26.1
28	8.8	11.2	13.2	15.0	16.7	18.0	19.6	20.9	22.0	23.0	24.2	25.2	26.2	27.1
29	9.7	12.0	14.0	15.9	17.6	19.2	20.5	21.3	23.0	24.1	25.2	26.2	27.2	28.1
30	10.5	12.9	14.9	16.8	18.5	20.0	21.4	22.8	23.9	25.1	26.2	27.2	28.2	29.1
31	11.4	13.8	15.9	17.8	19.4	20.9	22.4	23.0	24.8	26.0	26.9	28.2	29.2	30.1
32	12.2	14.7	16.8	18.6	20.3	21.9	23.3	24.6	25.8	27.0	28.1	29.2	30.1	31.1
33	13.0	15.6	17.6	19.6	21.3	22.9	24.2	25.6	26.8	28.0	29.0	30.1	31.1	32.1
34	13.9	16.5	18.6	20.5	22.2	23.8	25.2	26.5	27.7	29.0	29.5	31.1	32.1	33.1
35	14.9	17.4	19.5	21.4	23.0	24.6	26.2	27.5	28.7	29.9	31.0	32.1	33.1	34.1
36	15.7	18.1	20.3	22.2	24.0	25.0	27.0	28.4	29.0	30.9	32.0	33.1	34.1	35.2
37	16.6	19.2	21.2	23.2	24.9	26.5	27.9	29.5	30.7	31.8	33.0	34.1	35.2	36.2
38	17.5	19.9	22.0	23.9	25.8	27.4	28.9	30.5	31.5	32.0	33.9	35.1	36.0	37.0
39	18.1	20.8	23.0	24.9	26.6	28.2	29.8	31.2	32.5	33.6	34.9	36.2	36.9	38.1
40	19.2	21.6	23.8	25.8	27.6	29.2	30.7	32.1	33.5	34.7	35.8	36.8	38.1	39.1

## NOTE :

◎ In order to ensure a good operating environment of the laser, to reduce the probability of failure due to condensation. We recommend to prepare an air-conditioned room for the laser, so that the temperature in the air-conditioned room is  $\leq 28^{\circ}\text{C}$ , and the relative humidity is  $\leq 50\%$ . The water cooler should be placed in a different space from the laser. It is forbidden to place the water cooler in the air-conditioned room;

◎ The laser head works at circulating temperature. In order to avoid condensation on the laser head, it is necessary to adjust the temperature of the cooling water of the external light path to room temperature. It is forbidden to cool the laser head with low-temperature cooling water.



## 6-Structural Layout

Laser size chart (unit: mm)

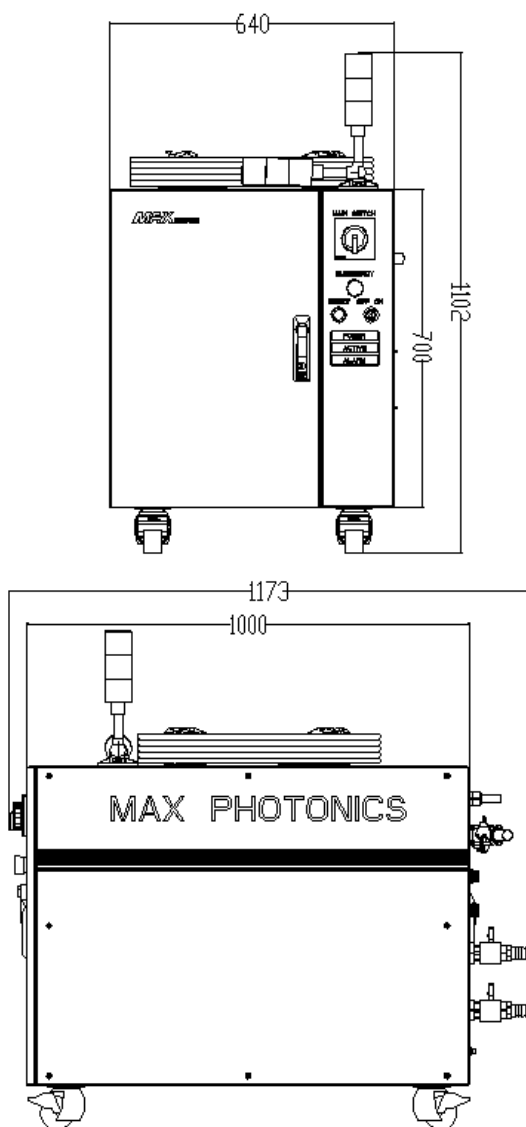

# Chapter 5

## Unpacking Guide

### 1-Unpacking Steps

The laser is precise valuables, so Maxphotonics recommends that you unpack the packing box according to the following steps:

1. Place the package containing the laser equipment on a horizontal surface, such as a concrete floor or a hard floor;
2. Open the packaging wooden box, remove the foam upper cover, and take out the accessories;
3. Check the “packing list” to check the accessories;
4. QBH and cable are placed on the top plate of the laser. Please take care carefully to ensure that the minimum bending radius of the fiber cable is >200mm.
5. After the accessories are taken out and counted, the laser is moved out of the box by a motorized forklift, the laser is placed on the flat ground, and the caster brake pads are pressed to prevent the laser from rolling by itself;
6. Please ensure that the laser is in a dry, ventilated, no dust; the 1 meter space around the laser is unobstructed, the front of the laser and the operator's location are unobstructed, the visual is unobstructed, there is no dripping above the laser, and the laser is located. The position is drained smoothly, and no water accumulation occurs.
7. Please purchase the same water pipe according to the water pipe sample attached to the package; the water pipe is connected to the laser inlet and outlet pipe pagoda joint, and is fastened with the attached hose clamp;

8. Save all items after unpacking to prevent future transportation or storage.

NOTES:

- ◎ If any damage of the external package and internal parts has been found upon receipt of product, please contact Maxphotonics Co., Ltd. or designated agent immediately.
- ◎ The air conditioner behind the laser has a drain port, connect the drain pipe, ensure that the drain pipe is level, and the height of any position of the drain pipe should not be higher than the outlet height of the drain pipe (if the laser matches the air conditioner).
- ◎ If the ambient temperature and relative humidity are high enough the laser will run a process of dehumidification for about 30 minutes. It is normal and the laser should be reboot again after the Condense Warning is released.
- ◎ The chiller should be closed when the laser is turned off in case that the moisture in the air condense on cool parts within the laser. When an air-conditioner is available it is suggested that you run the air-conditioner for half an hour before turning on the chiller and the laser power switch.

**Recommendation:** Change the environmental temperature and relative humidity and make the laser work away from the dew point (for example keeping the laser in a room with air-condition).

## 2-Packing List

No.	Names of fittings	Description	Unit	Quantity
1	Fiber Laser	MFSC-xxxx	pc	1
2	External signal wire		pc	1
3	Cable	10m	pc	1
4	Power keys		pc	2
5	USB disk	software enclosed	pc	1
6	Lens cleaning paper		pc	4
7	Sample of water pipe of laser	$\Phi 25.4\text{mm}$	pc	1
8	Hose clamps	Galvanized hose clamp, 26-38	pc	2
9	QBH water pipe sample tube	$\Phi 6 \times 4\text{mm}$	Pc	1

# Chapter 6

## Operation Guide

### 1-Notice

CAUTION:

- ◎ Please refer to Chapter 4 "Specification" for proper electrical power.
- ◎ Please refer to Chapter 2 "General Safety Information" for inspecting whether the configuration environment of peripheral work of the laser meets the requirements.

### 2-Electrical Power Connection

The laser power input line needs to be connected to three-phase four-wire AC. It is important to ensure that the zero-fire wire is correctly connected according to the line mark and the ground wire is well connected. Poor contact of the ground wire may cause potential damage to the laser.

For ensuring the safety feature, Maxphotonics recommends you connect a 63A circuit breaker (air switch) in series between the power supply unit and the laser. This electric power shall be in close proximity to the power supply unit of the equipment and can be easily disconnected.

Refer to Chapter 4 "Specification" to determine your electrical specification if you have any problem about wiring.

### 3-Extension Interface

The laser CTRL interface is a high quality multi-core air interface that provides a variety of signals for functional control of the laser, as described below:



5000W-6000W 24P air interface

Ctrl Interface Pin	Wire Color	English logo	Chinese logo	Notes
15	black	Modulation input+	调制输入 +	20 VDC $\leq$ V $\leq$ 28 VDC I $\leq$ 15mA
4	Black and white	Modulation input-	调制输入 -	
16	red	Emission Enable input+	使能输入 +	20 VDC $\leq$ V $\leq$ 28 VDC I $\leq$ 15mA
3	Red and white	Emission Enable input-	使能出入 -	
12	green	DA(0-10V) input 0~10V+	0-10V 输入 +	Control laser output power, Around 1-10VDC. 1V corresponds to 10% power; 10V corresponds to 100% power.
5	Green and white	DA(0-10V) input 0~10V-	0-10V 输入 -	
6	yellow	External laser output+	外部出光 +	20 VDC $\leq$ V $\leq$ 28 VDC I $\leq$ 15mA
7	Yellow black	External laser output-	外部出光 -	
18	Brown	ERROR1	故障输出 1	Dry contact output, ON- fault, OFF- normal, (contact voltage V $\leq$ 30VDC, contact current I $\leq$ 100mA)
23	Brown and white	ERROR2	故障输出 2	
1	purple	LASER_RDY_OUT+	设备状态 +	Reserved
2	Purple black	LASER_RDY_OUT-	设备状态 -	
8	Orange	EX LOCK+	互锁干接点输入 +	± Short connection: the laser normally controls the light output ± Disconnected: the laser is locked and cannot emit light
19	Orange black	EX LOCK-	互锁干接点输入 -	

21	Light blue	EX EMERGENCY+	急停控制 +	Input high level alarm $20 \text{ VDC} \leq V \leq 28 \text{ VDC}$ $I \leq 15 \text{ mA}$
14	Light blue black	EX EMERGENCY-	急停控制 -	
17	Light green	EX RED CONTROL+	红光控制 +	Reserved
24	Light green black	EX RED CONTROL-	红光控制 -	

## 4-Start Steps

### WARNING:

- ◎ Make sure that all the electrical connections (including cooling water connections) are connected prior to use. All the connectors must be held steady with screws if possible.
- ◎ NEVER look directly into the output fiber and make sure that you wear the laser safety eyewear while operating the product. Make sure all power is removed from the laser when wiring.

### Start steps are as follows:

- 1、 Start the Chiller;
- 2、 Remove the end cap of the collimator;
- 3、 Make sure that the end surface of the collimator is clean and not covered with impurities;
- 4、 Make sure that the emergency stop switch is turned on;
- 5、 Place the Power Main Switch of the front panel on position "ON";

- 6、 Place the Key Switch of the front panel on position "ON";
- 7、 Press the START button on the front panel.
- 8、 Air conditioning: The system automatically controls the air conditioning switch. The air conditioner starts to cool after 3 minutes, and if it does not cool after 3 minutes, the air conditioner fails (if the laser matches the air conditioner).

### 5-Mode Description

**The working modes of the laser are as follows:**

- 1、 CW Mode: The light emitted is continuous and this mode is used for cutting.
- 2、 Modulated Mode: The light emitted is pulsed and this mode is used for controlling the output average power of the laser.
- 3、 External Control: Control the output of the laser via external control software.

#### External Control Signal Timing:

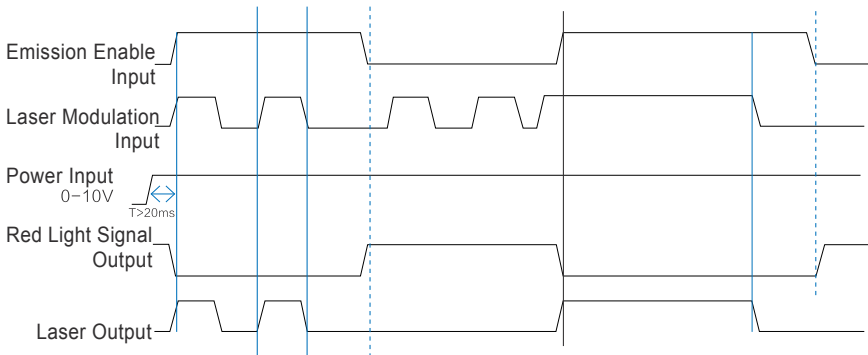



## 6-Software Description

(1) Enter "Chuangxin Laser Official Website"->"Download Center"->"Install Software", and download "G3 Series-Software Installation Guide", "NET4.6", "G3-Series-n.n.n.n". (The version is updated from time to time, subject to the official website announcement without notice.)

URL: <http://en.maxphotonics.com/En/Software.html>

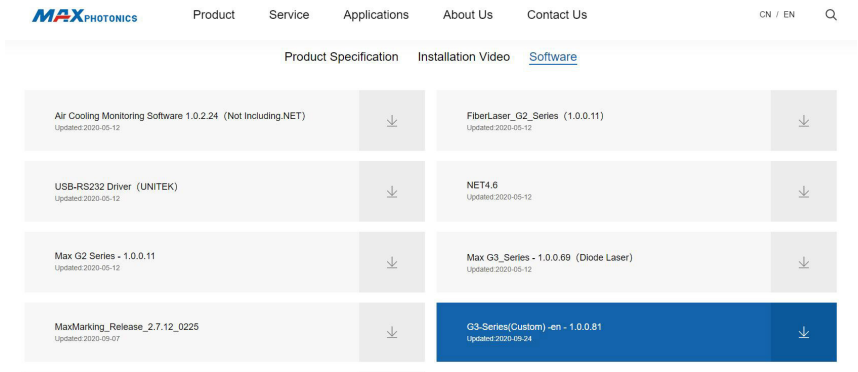

Product Specification	Installation Video	Software
Air Cooling Monitoring Software 1.0.2.24 (Not Including.NET) Updated:2020-05-12	↓	FiberLaser_G2_Series (1.0.0.11) Updated:2020-05-12
USB-RS232 Driver (UNITEK) Updated:2020-05-12	↓	NET4.6 Updated:2020-05-12
Max G2 Series - 1.0.0.11 Updated:2020-05-12	↓	Max G3_Series - 1.0.0.69 (Diode Laser) Updated:2020-05-12
MaxMarking_Release_2.7.12_0225 Updated:2020-09-07	↓	<b>G3-Series(Custom) -cn - 1.0.0.81 Updated:2020-09-24</b>

(2) Decompress the downloaded compressed package, and install the operating environment (NET4.6) and monitoring software (G3-Series-n.n.n.n) referring to the "G3 Series-Software Installation Guide". (Win10 system or system with .NET 4.6 installed, no need to install NET4.6).

(3) After installing the operating environment and monitoring software, a "G3-Series" shortcut will appear on the desktop.



- (4) Check whether the communication interface of the laser backplane is RS232 or EtherNet, connect it to the computer, and power on the laser.
- (5) Double-click the desktop "G3-Series" shortcut to open the monitoring software and enter the following connection interface.



- (6) If the laser backplane is an RS232 interface, the monitoring software communication mode is selected as COM (the default is COM), and the corresponding COM number is selected, and then click the "Login" button to try to connect with the laser.
- (7) If the laser backplane is an EtherNet interface, select the communication mode of the monitoring software as IP2, enter the laser IP address (default is 192.168.0.178), and click the "Login" button to try to connect with the laser.



If the laser is powered on and the model can match the monitoring software, it will enter the following monitoring interface.

(8) Click the "Login" button to connect the laser and enter the following monitoring interface.



(9) Decrypt the page.

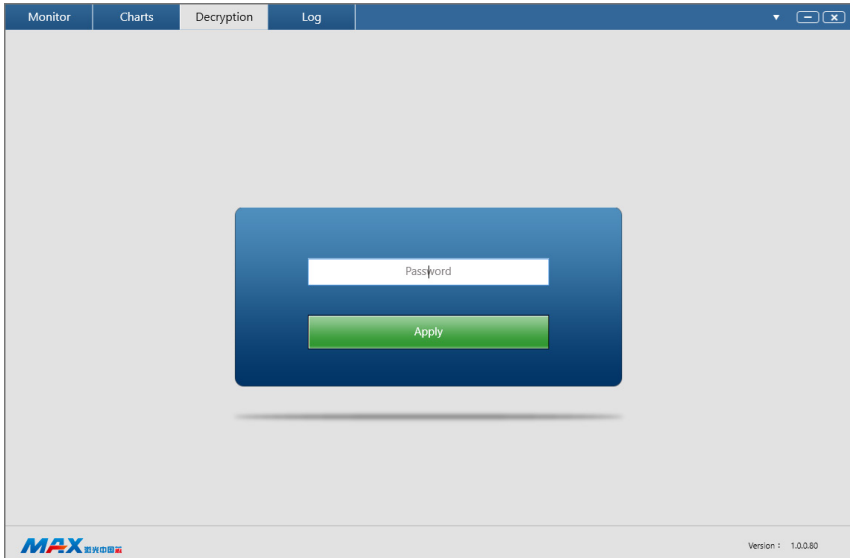

Tips: For the specific details of software installation and instructions, please refer to the relevant instructions of the official website software.

## 7-Error List

The fault alarm points set by the laser include:

No.	Message	Description	Trouble shooting
1	PD alarm	Laser internal light path testing fault	Operation leads to low output power of laser such as low modulation frequency, low peak power, low cutting power.
2	Water flow warning of the chiller	The chiller is not started or water flow is not sufficient	Start the chiller and make sure that there is sufficient water flow in the water line.
3	Overheat alarm	Overheat fault of the laser	For the internal overheat fault of the laser, please check whether the pre-set temperature of the chiller meets the requirements. Shut down the laser and do not restart it until the heat accumulated during operation dissipates thoroughly.
4	Overcurrent alarm	Overcurrent fault of the laser	If "0-10V" DA value exceeds the pre-set value, the internal overcurrent fault will occur.
5	QBH installation alarm	Install error of the QBH	The fault will be produced when QBH head is not inserted into the cutting head or at the wrong place.
6	Emergency stop alarm	The emergency stop switch is pressed	Release the emergency stop switch, the laser will work again after being restarted.
7	Communication error of RS232	Communication error between the laser and the PC	Check the RS232 interface and cable of the computer.

Note:

© All the alarm message will be displayed on the Monitor Software. Please pay attention and contact our service personnel if you need.

# Chapter 7

## Fiber Connector Inspection and Cleaning Guide

### 1-Notice

It is imperative that the fiber connector is checked for dust, dirt, or damage every time it is connected to any optical device, before use. The use of a dirty or damaged fiber connector can result in serious injury and/or laser damage. Maxphotonics is not responsible for any damage due to contaminated connectors.

**For cleaning a fiber connector, you need the following materials:**

- 1、 Powder-free rubber gloves or fingerstall
- 2、 Lint free optical cleaning wipes and/or swabs
- 3、 Anhydrous ethanol (Optical level, pure >99.5%)
- 4、 Acetone (Optical level, pure >99.5%)
- 5、 Compressed air (oil free, water free)
- 6、 Microscope
- 7、 Light source

**IMPORTANT :**

© It is imperative that you wear powder-free rubber gloves during this cleaning procedure! It is hereby stated that damage to the fiber connector can occur due to mishandling, the use of incorrect cleaning procedures, or chemicals for cleaning. This is not covered by the Maxphotonics' warranty. Anhydrous ethanol

and acetone should be managed and stored according to the local law and instructions.

## 2-Operating Procedures

Clean and maintain the fiber laser according to the following procedures:

- 1、 Switch off the laser power, and place the key switch on position of “OFF”
- 2、 Remove the black outer protective sleeve and leave the white inner cap on and clean the fiber connector exterior with optical cleaner, wipe it with a clean optical wipe and dry it with compressed air;
- 3、 Place fiber connector in the holder of the microscope; (7-1)
- 4、 Remove the protective inner cap from the connector; (7-2)
- 5、 Focus the microscope onto the connector surface;
- 6、 Use a light source to illuminate the face of the fiber connector so that the light is reflected off the surface of the endface. This is achieved if you see a bright golden shine from the QBH connector endface.
- 7、 Inspect the endface surface carefully. Contamination will lead to dark spots/burns on the surface and possibly damage to the fiber and/or laser. If contamination is visible on the endface, cleaning is necessary.
- 8、 Take out the cap and sleeve, then connect the fiber connector with the cutting head quickly and fasten them. (Place the cap face down on a clean surface or a lint-free wipe.)



7-1 Remove the fiber protective sleeve and protective film

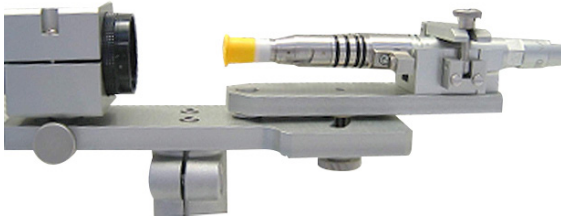

7-2 Install the fiber connector under microscope



7-3 Cleaning protective lens with swabs



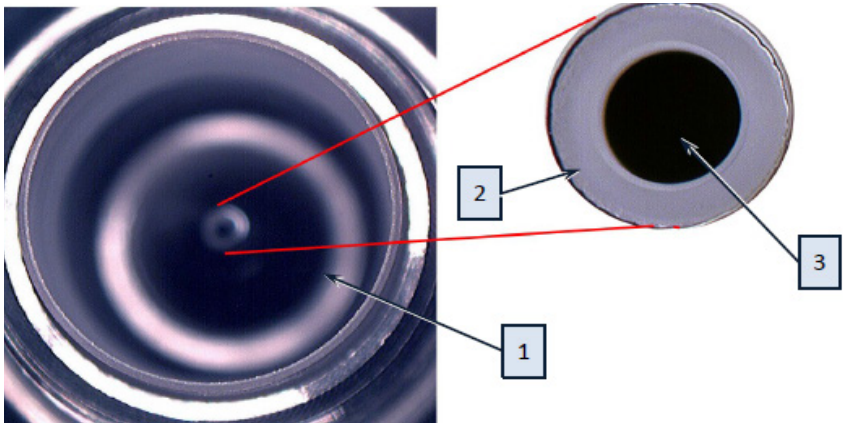

1、 quartz

2、 fiber cladding

3、 fiber core

7-4 Actual image of the fiber

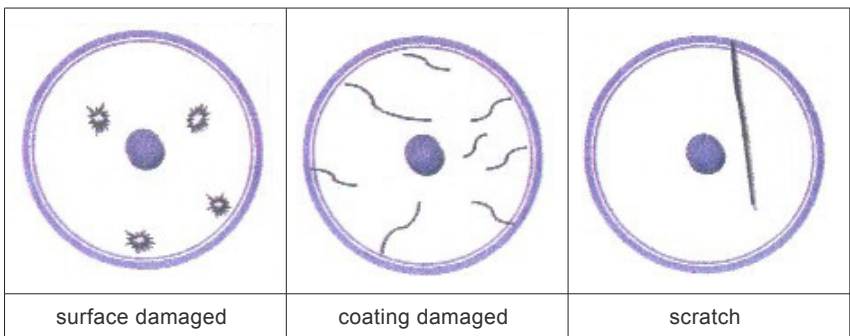

surface damaged

coating damaged

scratch

7-5 Endface may be damaged

**IMPOTANT :**

- ⦿ Do not reuse a lint-free optical wipe or swab.
- ⦿ Do not touch the protective lens of the fiber connector.
- ⦿ Do not blow directly, or else new dirty will be brought.
- ⦿ Do not touch the tip of the cleaning swab with your fingers.
- ⦿ Cleaning is necessary before place the protective cover and sleeve.
- ⦿ Never blow air directly at the surface, because you could imbed contaminants into the surface. Always blow across the surface!
- ⦿ If the fiber connector could not be installed in optical system immediately, please cover it with the protective cap cleaned with compressed air.

**CAUTION :**

- ⦿ It is hereby stated that damage to the fiber connector can occur due to mishandling, the use of incorrect cleaning procedures, or chemicals for cleaning. This is not covered by the Maxphotonics' warranty.

# Chapter 8

## Service and Maintenance

### 1-Maintenance Notes

#### CAUTION :

- ◎ No operator serviceable parts inside. Refer all servicing to qualified Maxphotonics personnel.
- ◎ For ensuring that the repairs or replacement within the warranty scope can be carried out, and perfectly maintaining your interests, please submit application to the Maxphotonics or the local representative after finding the faults. Upon receiving our authorization, you need to pack the product in a suitable package and return it.
- ◎ You should keep the proof when finding any damage after receiving the product, so as to claim the rights to shippers.

#### IMPORTANT :

- ◎ Do not send any product to Maxphotonics without RMA.
- ◎ If the product is beyond the warranty period or the warranty scope, customers shall be responsible for the repairing cost.

#### CHANGE :

- ◎ We have the rights to change any design or structure of our product, and the information is subject to change without notice.

## 2-Service Statements

More problems regarding the safety, set-up, operation or maintenance please reading this "User Guide" carefully and following the operation steps strictly. Please call the Customer Service Department for other questions.

Please call the Customer Service Department for other questions: 400-900-9588.

Your problems will be follow-up by our technical support group after verified. If the problems cannot be solved , you may need to return the product to Maxphotonics for further troubleshooting.

# Chapter 9

## Warranty Statements

### 1-General Clauses

Maxphotonics Co.,Ltd. carries out warranty for any defect of the product caused by its material and production technology within the warranty period agreed in contract, and ensures that its product meet the relevant quality and specification requirements specified in the document under normal use condition.

Maxphotonics Co.,Ltd. rationally determines to repair or replace the products with faults caused by its material or production technology within the warranty period, and repairs or replacement of all the products within the warranty scope are carried out according to the rest of the warranty period of primary products.

### 2-Warranty Limitations

Under the following circumstances, the products, parts (including the fiber connectors) or equipment are not within the warranty scope:

- (1) Tampered, opened, detached or reconstructed by personnel outside Maxphotonics;
- (2) Damaged from misuse, neglect or accident;
- (3) Used beyond the specification and technical requirements of the product;

- (4) Indirectly damaged from users' software or interfaces;
- (5) Improper installation or maintenance, or operating under conditions not included in this manual;
- (6) The fittings and the fiber connectors are not included in the warranty scope.

Customers are obligated to understand the information above and operate according to the User Guide and specification, or the faults arising therefrom are not included in the warranty scope.

**IMPORTANT:**

- © Within the warranty scope, purchasers must feed back within 31 days after finding the product defect.
- © Maxphotonics does not grant any Third Party rights to repair or replace the parts, the equipment or other Maxphotonics products.